

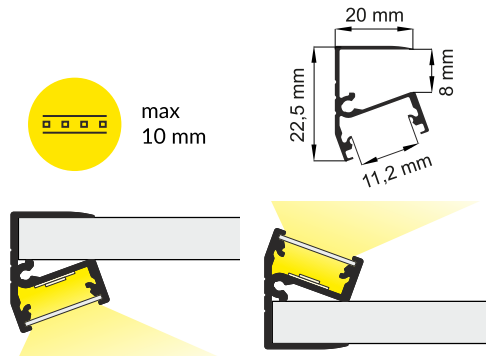



EDGE10 BC/UX

GLASS PROFILE / DO SZKŁA



- 
 scissors
 nożyczki
- 
 pliers
 kombinerki
- 
 hacksaw
 piłka
- 
 soldering iron
 lutownica
- 
 solder
 cyna

- B** B slide cover
klosz B wsuwany

C C cover click/lens
klosz C klik/
soczewka

1 EDGE10
ending
with hole
zaślepka
EDGE10
z otworem

2 power supply
cable
kabel zasilania

3 LED power
supply
zasilacz LED

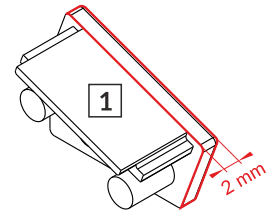
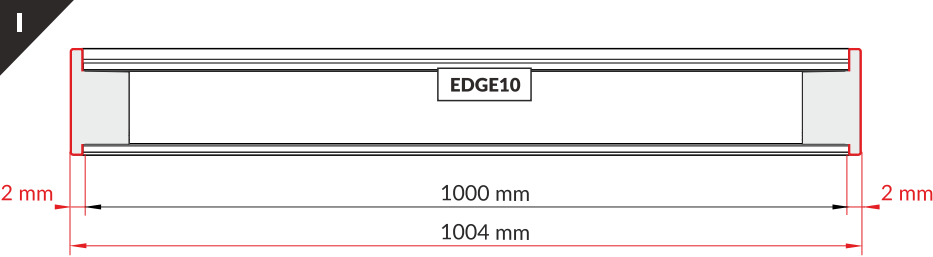

Note! Ending thickness increases the length of the luminaire (+ 2 x 2 mm).
Uwaga! Grubość zaślepki zwiększa długość oprawy (+ 2 x 2 mm).

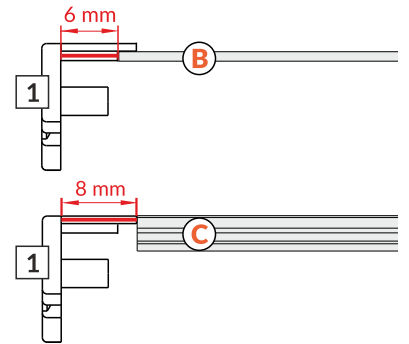
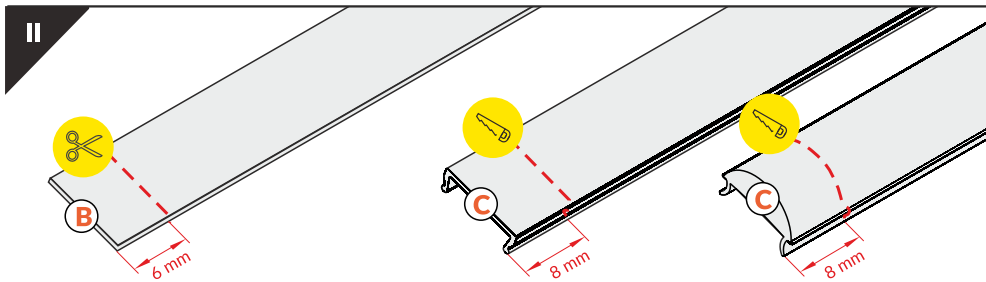

Note! Ending decreases the length of the cover -
Uwaga! Zaślepka zmniejsza długość klosza -
B -2 x 6 mm; **C** -2 x 8 mm.

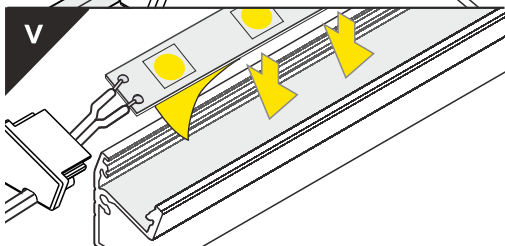
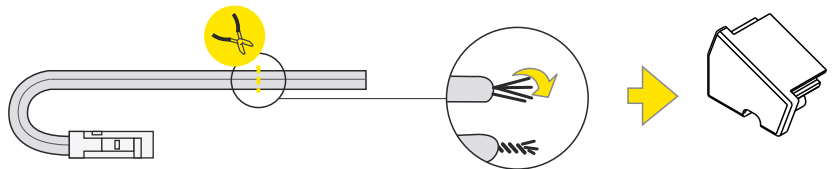
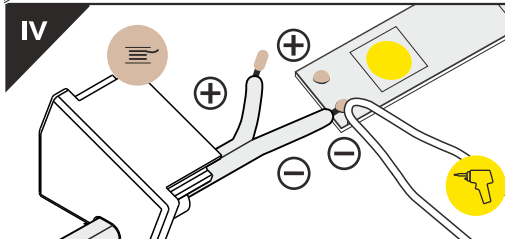
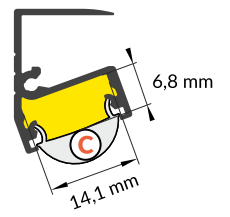
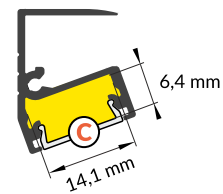
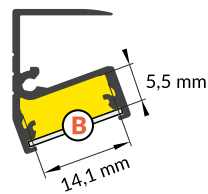
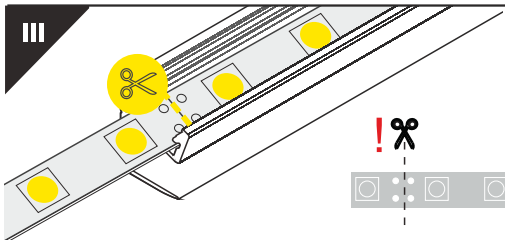

VI

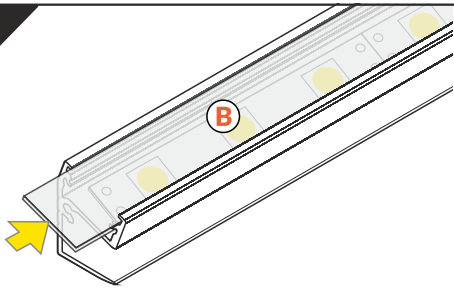

B slide cover / klosz B wsuwany

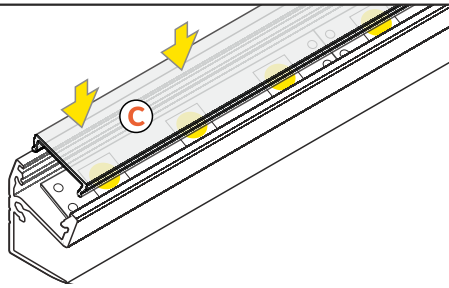

C click cover / klosz C klik

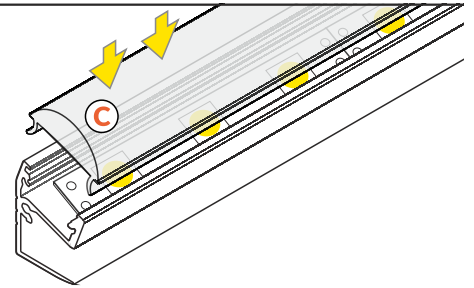

C click cover / klosz C klik

VII MOUNTING / MONTAŻ

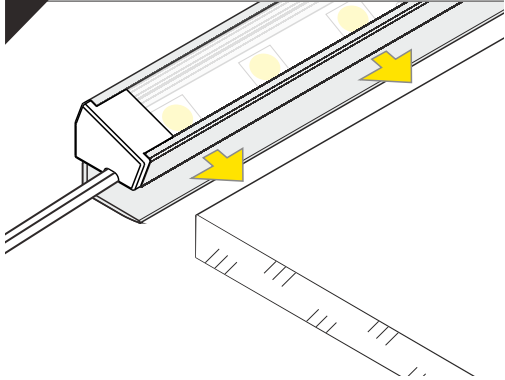

Profile mounting on a glass shelf / Montowanie profilu na półce szklanej

IX

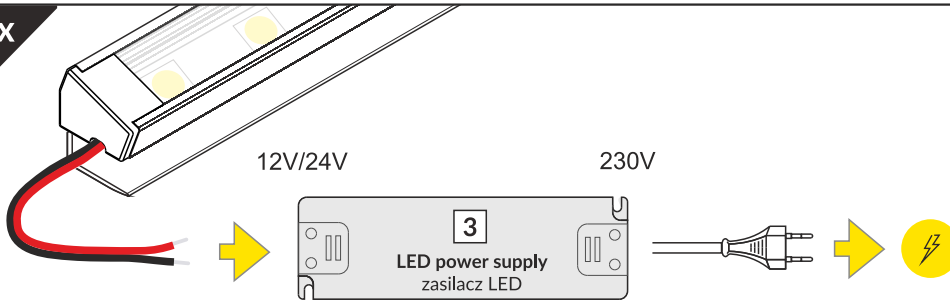

ACCESSORIES / AKCESORIA

- power switches
- controller + remote
- movement sensors
-
- włączniki
- sterownik + pilot
- czujniki ruchu

Check the rest - TOPMET catalogue or www.topmet.co.uk
Zobacz więcej - katalog TOPMET lub www.topmet.pl